

EXCEL

direct

PRODUCTS

Seating Products



The Modern Classroom

Excel is the tool that will cross boundaries of “immobile” classrooms, enabling educators to provide a modern and effective arena for learning. Excel is designed to be mobile and adaptable in limited spaces and dense classrooms. A room can be transformed from theatre setting to a U-shaped setting effortlessly by moving the chairs around. This allows for maximum utilisation of space as well as increasing interaction between student and teacher.



Model: 92_BC AW1 AP



Features



Back shell design breathes like mesh.

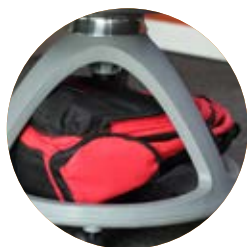

The base tray provides approximate 35 liters space for personal belongings.

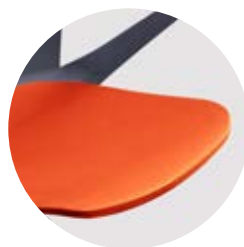

Plastic seat shell comes in 3 colour options and require less maintenance.



Foldable A4 size writing tablet with Anti-Panic mechanism is tested to 50kg loads.

Model: 92_BD AW1 AR



Features



Back shell design breathes like mesh.



The base tray provides approximate 30 liters space for personal belongings. Pockets on both side for drinks bottles etc.

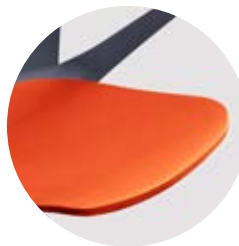

Plastic seat shell comes in 3 colour options and require less maintenance.



A3 size tablet, 360° swingable on its support arm. Slot for tablet or mobile devices.

Seat Shell

Injection-moulded polypropylene shell in choice of 3 colours (100% recyclable).

Optional Seat Upholstery

Upholstered over polyurethane cut foam (recyclable into carpet padding, wadding etc).

Tablet

Model: BD

A3 size tablet can swing 360° on its support arm for left or right handed rounded seat. Slot for tablet or mobile devices.

Base

AR Square Base

Moulded polypropylene base in standard grey colour equipped with 50mm dual-wheel castors.

Chair Shell

Injection-moulded polypropylene shell in white or grey (100% recyclable).

Tablet

Model: BC

Writing tablet uses an anti-panic mechanism and is tested to 50kg loads. Its generous size accommodates an open A4 book or 15" notebook computer. Recessions for a pen and cup.

Base

AP Tri-pod Base

600mm diameter storage base of grey moulded polypropylene equipped with 50mm dual-wheel castors.



PP Seat
923P BC AW1 AP



Padded Seat
924P BC AW1 AP

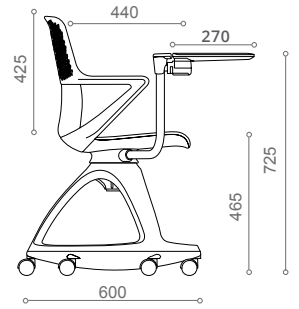
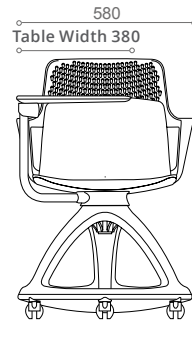

923P BD AW1 AR



924P BD AW1 AR

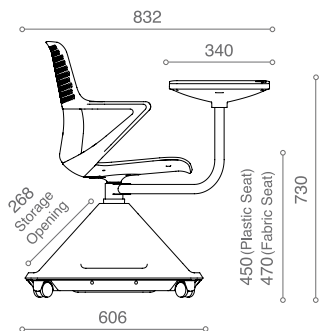
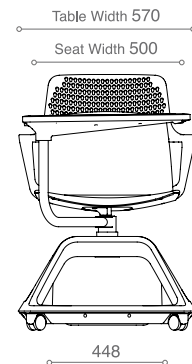

923G HB A71 N3



924G HB A71 N3

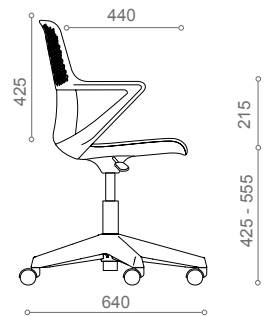
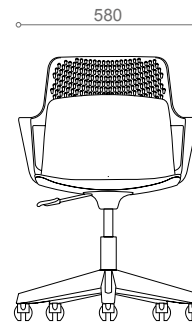

Fresno: Option

Excel: Option
PP Seat Colour

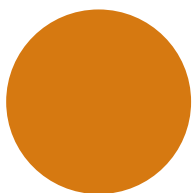

Mango
(M)

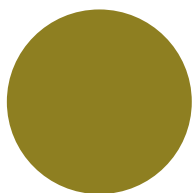

Olive
(L)

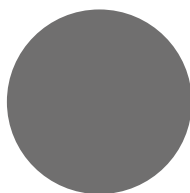

Charcoal
(C)



Direct Products Postal

PO Box 1029, Kunyung, 3931, Vic, Aus

Direct Products Office

1A / 15 Carbine Way, Mornington, 3931, Vic, Aus

Phil Ellis | Director

Phone: 0412 357 499 | Email: phil@directproducts.net.au

Nick Ellis | Sales Executive

Phone: 0438 006 731 | Email: nick@directproducts.net.au

General Information

Email: sales@directproducts.net.au

A decorative graphic consisting of numerous thin, parallel teal lines that curve from the bottom left towards the top right, creating a sense of motion and depth.

www.directproducts.net.au